

HIGH REACH DEMOLITION

ZAXIS470LCH

A P P L I C A T I O N & A T T A C H M E N T



Model Code	ZX470LCH-5B
Engine Rated Power	270 kW (362 HP)
Operating Weight	55 700 - 63 200 kg
Attachment Tool Weight	2 500 / 3 000 / 4 500 kg



WALK AROUND

CONTENTS

4-5 Performance

Time- and fuel-saving features will help to boost efficiency and productivity.

6-7 Comfort

Enhanced visibility and user-friendly features create a comfortable work space.

8-9 Durability

Hitachi high reach machines are built to conquer the most challenging demolition sites.

10-11 Safety

The new safety features on the ZX470LCH-5 excavator contribute to a better working environment.

12-13 Maintenance

Easily accessible features for cleaning and routine maintenance maximise the availability of the ZAXIS 470.

14-15 Hitachi Support Chain

All our customers benefit from a wide range of after-sales services and support options.

16-25 Specifications

Ultimate comfort

The fully adjustable air-suspension seat slides further back than ever before, providing more leg room.

HIOS III B hydraulic system

Higher productivity is achieved by the HIOS III B hydraulic system, which results in better fuel consumption than the conventional Zaxis model and helps to reduce costs.

Hydraulic connecting pins

The time for assembling and disassembling front attachments has been reduced dramatically with the hydraulic connecting pins.



The design of every Hitachi excavator has one aim: to empower your vision. The new Zaxis-5 range of high reach demolition machines retains many of the benefits of the Zaxis-3 models, but has also been given many new features that enhance its performance, comfort, durability and safety. Our goal is to provide customers with high-quality and efficient machines that can work reliably in the dynamic demolition industry. We also want operators to feel comfortable and safe while they work, and ultimately to enjoy using Hitachi machinery. And to support you and your investment, we have created the comprehensive Hitachi Support Chain after-sales programme, available via your local Hitachi dealer.



The image shows a large orange Hitachi Zaxis-5 excavator with a high-reach demolition attachment. The excavator is positioned on the left side of the frame, with its boom extended upwards and to the right. The attachment is a large, orange, multi-jointed structure with a long, thin boom and a large, rectangular bucket at the end. The bucket has a grid-like pattern on its front face. The excavator's body is visible at the bottom right, showing the cab and tracks. The background is a plain, light grey color. The excavator and its attachment are reflected on a glossy surface below them.

Tilt cylinder guard

Added durability is provided by the tilt cylinder guard, which protects the cylinder from falling objects.

Easily accessible information

The front attachment mode selector is displayed on the multi-function monitor, so you can quickly change the hydraulic circuit of the machine for the specific attachment to be installed.

Strengthened frame

The main frame has been reinforced at the boom foot and boom cylinder bottom bracket, especially for demolition.

Tilting cab

The tilting mechanism allows the operator to choose the best position for maximum visibility.



PERFORMANCE

Competitive deadlines on demolition projects demand a consistently high level of performance from your machine. Consequently, we understand that our customers are looking to invest in the most efficient excavators on the market. That's why we have prioritised the performance characteristics of the Zaxis-5 high reach demolition models, with a variety of measures to increase speed to help you get the most from your machine.



High levels of efficiency and productivity to maximise uptime

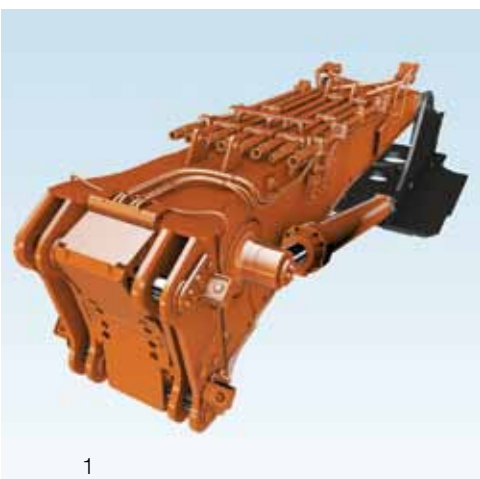

1
Hydraulic connecting pins



2
Stand for front attachment



3
Lever type quick couplers

Optimum operational hours

The Hitachi ZX470LCH-5 incorporates a number of time-saving features to boost productivity levels on the job site. The time required for changing attachments has been reduced remarkably, for example. The hydraulic connecting pins (1) allow for the quick assembly and disassembly of attachments, which helps to maximise operational hours. The device includes a hook and four connecting pins for easy connection of the front attachment to the base boom. A position sensor ensures that the pins are connected safely and securely.

The new high-pressure couplers and lever-type quick couplers (3) also contribute to a shorter changeover of front attachments.

In addition, the front attachment mode selector is now displayed on the multi-function monitor, so you can change the hydraulic circuit of the machine, according to the specific front attachment to be installed, quickly and conveniently from the operator's seat.

A stand (2) for the machine's front attachment is also provided to support it, which is lightweight for easy transport and set-up. The counterweight available for the ZX470LCH-5 is a segmentation type. It can be mounted on to the machine using a small crane.

Lower fuel with higher productivity

The efficient performance of your equipment ultimately determines the success of your demolition business. We believe that your investment in Hitachi construction machinery can help you to meet deadlines and compete successfully to win tenders within your market.

Key features

- Hydraulic connecting pins (1)
- Front attachment mode selector
- Lever-type quick coupler (3)
- Front stand (2)
- HIOS IIIB hydraulic system – higher productivity and lower fuel consumption
- 13% less fuel consumption in PWR mode (vs ZX-3 HP mode)*



COMFORT

The comfort of operators on demolition sites was an important consideration for the Hitachi engineers who designed the Zaxis-5 high reach demolition machines. After listening to the needs of customers and operators from all around the world, they strived to create a user-friendly working environment, with enhanced visibility of the job site and a variety of practical features to enhance the overall operating experience. The result is a demolition machine that helps you to deconstruct buildings and structures with relative ease and a sense of job satisfaction.



Operator comfort is a key consideration for demanding demolition work



Roof window wiper and pillar-less window



Efficient tilting mechanism



Parallel front window wipers

Take in the view

An enhanced view of the job site is extremely advantageous on challenging job sites, allowing you to work accurately, while sitting in a comfortable position, and avoiding potential risks. Several new features have been incorporated into the design of the Zaxis-5 high reach demolition models to help you do exactly that.

The new ZX470LCH-5 excavator has been designed with pillar-less glass in the cab (1) – the upper horizontal part of the window frame has been removed to increase upward visibility and give an uninterrupted view of high reach demolition work.

The windows of the cab are made of laminated safety glass. The front wipers (3) have been repositioned in parallel to the window, ensuring that it can be cleaned effectively, especially the upper part. The roof window wiper (1) also provides improved upward visibility.

Using the smooth and efficient tilting mechanism (2), you can maximise your visibility while remaining comfortable, by tilting the cab to an angle of up to 30 degrees. The design ensures that this feature does not increase the height of the cab and eliminates the projection of any parts, which is important for transportation purposes.

Enjoy your work

For additional comfort, the cab of the new Hitachi high reach demolition machine benefits from a viscous mount system, which reduces any vibrations and helps to minimise fatigue. The fully adjustable air-suspension seat brings similar benefits and can also slide further back than ever before using a new sliding mechanism, therefore providing more leg room.

The user-friendly functionality of the new ZX470LCH-5 is demonstrated by the cab's ergonomic controls and the multi-function LCD colour monitor. The seven-inch screen displays a comprehensive range of useful technical information at a glance. The attachment support system with 11 modes, can be registered on the monitor for the easy fitment of different attachments. These two auxiliary spools are useful for attachments that require multiple, large volumes of oil flow.

The pressurised cab prevents dust penetration and is also sound-insulated, which reduces noise levels from the job site and helps to create a more relaxed working environment. It also helps you to listen to music while you work more easily, either from the AM/FM stereo radio or from a personal MP3 player. An auxiliary socket has been added to the sound system to facilitate the use of MP3 players.

Key features

- Pillar-less window in the cab (1)
- Tilting mechanism (2)
- Parallel wipers and roof window wiper (3, 1)
- Ergonomically designed control panel
- Enhanced visibility
- Heated air-suspension seat
- Attachment support system



DURABILITY

The new range of Hitachi high reach demolition excavators lives up to our industry-leading reputation for high-quality construction machinery, which has been established over more than 40 years. The ZX470LCH-5 has been built to withstand the rigours of the toughest demolition job sites, and is equipped with several features ensuring its reliability and durability. We realise that these are key factors for meeting the requirements of increasingly complex demolition projects on time and on budget.



High levels of availability on tough demolition sites



Tilt cylinder guard

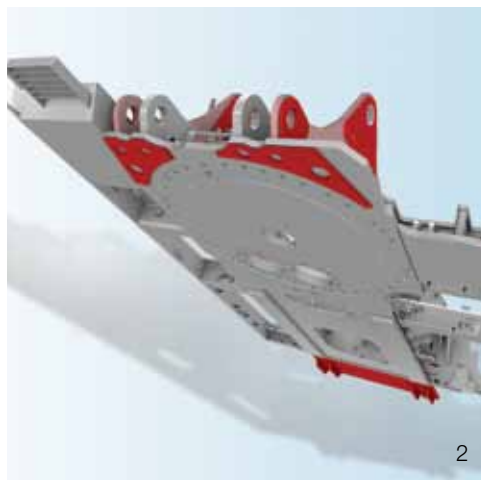

Strengthened frame



Durable covers

A lower cost of ownership

Our main aim behind manufacturing durable high reach demolition machines was to ultimately lower the cost of ownership for our customers. The ZX470LCH-5 incorporates several features designed to ensure high levels of availability, prevent damage and minimise downtime.

One example is the tilt cylinder guard (high reach demolition) (1), a tough metal cover that protects the cylinder from potential damage caused by falling objects such as concrete blocks and debris.

The new Zaxis-5 high reach demolition machines have also been designed with a strengthened frame (2) especially for this application. The main frame has been reinforced at the boom foot and boom cylinder bottom bracket.

The track and reinforced upper structure are also given additional protection on the job site by durable covers (3). They protect the covered hoses, piping and valves from obstacles during operation.

Durable parts you can rely on

The ZX470LCH-5 is also equipped with durable parts including a filter-type high-performance water separator that captures moisture in the fuel, reducing impurities and helping to minimise any fuel-related engine problems. Dual fuel main filters and pre-filters are provided as standard to reduce fuel system failures.

Key features

- Proven Hitachi quality
- Tilt cylinder guard (high reach demolition) (1)
- Strengthened frame for demolition (2)
- Track and reinforced full upper structure under cover (3)
- More than 40 years of experience
- Dual fuel main filters and pre-filters



SAFETY

Health and safety are of paramount importance on busy demolition sites. So Hitachi has prioritised the incorporation of several safety features in the design of the new Zaxis-5 high reach demolition excavators. This serves to give you peace of mind that your Hitachi excavator not only meets the industry standards, but also contributes to creating better working conditions for you and your colleagues.



Enhanced safety features will protect you and your investment



Openable OPG top guard (Level II)



Swing angle alarm and HRD overload warning system



OPG front guard (Level II)

Safety comes first

The safety features on the ZX470LCH-5 have been designed to protect you while you work and to avoid any unnecessary damage to the machine, ultimately saving you time and money.

The new excavator has sturdy OPG (Operator Protective Guard) as standard. It has an OPG top and front guard (1, 3) that meet ISO safety standards for operator protection. To allow for easy access for cleaning, the OPG top guard (1) can be opened, and the gap between the front guard and window has been expanded. The crossbars on the top guard are aligned to ensure that they do not hinder the visibility of the operator.

A better working environment

A swing angle alarm (2) has been fitted to the new high reach demolition machine, which highlights when the machine swings close to its limit and is approaching a potentially unstable position. This is also highlighted on the cab's monitor as an additional alert.

Another safety warning comes with the HRD overload warning system (2). When the machine inclines close to its limit, it shows the load ratio on the monitor by sensing the boom angle and pressure.

A rear-view camera on the counterweight is fitted as standard on the ZX470LCH-5. It links to a widescreen colour LCD screen to give you a clear view behind the machine. The rear-view camera works automatically when the excavator is travelling and can be manually turned on with a switch on the monitor.

Key features

■ Swing angle alarm (2)

■ Openable OPG top guard (Level II) (1)

■ OPG front guard (Level II) (3)

■ HRD overload warning system (2)

■ Rear-view camera



MAINTENANCE

When it comes to the regular maintenance and cleaning of your ZAXIS 470, we know that convenience is of utmost importance. With a range of easily accessible features, Hitachi large excavators are now easier and quicker to maintain than ever before. This gives our customers more time to focus on the job at hand and guarantees the optimum availability that Hitachi machines can deliver.



Easily accessible features keep your machine working longer



Easy access

The design of the new ZAXIS 470 incorporates a range of convenient features for routine maintenance. They have been created by our engineers in order to save you time and make life a little less stressful. The multi-function LCD monitor allows you to manage machine maintenance information quickly and efficiently. And each time you turn on the ignition switch, you can also set the routine service schedule to help prevent breakdowns.

The fuel filters and engine oil filter can all be replaced from the excavator's walkway. Other work on the upper structure of the machine, like replacing the air cleaner, can be carried out easily.

Easy servicing

The new ZAXIS 470 is equipped with a solenoid fuel pump, which means there is no need to pump manually if the engine stops due to lack of fuel or while the main fuel filter is being changed.

The machine's utility space stores an electric grease pump, hose reel and tool box. This means that batteries and an electrical equipment box are conveniently located in one place.

Easy cleaning

To maximise productivity and ensure optimum levels of availability in the quarry or on any construction site, we have introduced a variety of quick solutions to the new ZAXIS 470 for routine maintenance and cleaning.

One example of these convenient features can be seen on the exterior of the machine, where the air conditioning condenser can be easily opened for cleaning the condenser and radiator located behind. The cleaning process is also easier thanks to the parallel positioning of the cooling package.

Key features

- Easy daily inspection
- Quick and easy service access
- Relocated filters
- Solenoid fuel pump



SUPPORT CHAIN

As soon as you become a Hitachi customer, you can rely on first-class after-sales service from your authorised dealer. Hitachi provides extensive support to each of the dealers within the European network, so that they can ensure your ZAXIS 470 continues to meet your requirements and exceed expectations. To further protect your investment in Hitachi construction machinery, we have introduced the Hitachi Support Chain after-sales programme. This gives you the flexibility to create a tailor-made service plan from the following key-areas, "links" in the chain of service available from Hitachi via your local dealer.



Flexible after-sales programme to protect your investment

Global e-Service

The new ZAXIS excavator is equipped with a GPRS communication system*. This sends a wide range of machine data to the Hitachi main server. Via the Global e-Service database, you will have remote access to all of this data. All you need is an internet connection and your Global e-Service log-in details.

Global e-Service enables you and your dealer to download and share this data, helping you to remotely manage your fleet. The online facility also helps your dealer to proactively advise you on preventive maintenance and related special offers.

The latest information on the ZAXIS excavator is available 24/7 and includes operational data, such as the number of working hours, fuel consumption figures, working modes and location. This helps you to reduce running costs, plan jobs efficiently and keep up to date with machine maintenance – to ensure optimum performance and minimal downtime.

Technical support

The professional and highly trained Hitachi service team combine the global expertise and knowledge of Hitachi Construction Machinery with your local language and culture. We take a proactive approach towards customer service by continuously training our dealer personnel, so that the available global knowledge is passed on to each individual technician in our dealer network.

Extended warranty and service contracts

Every new Hitachi model is covered by a full manufacturer's warranty. However, your ZAXIS excavator may require extra protection due to severe working conditions or to minimise equipment repair costs. To meet these demands, our dealers offer the option of a unique extended warranty programme (HELP – Hitachi Extended Life Program) and comprehensive service contracts – the most effective way to optimise the performance of your new ZAXIS excavator.

Parts and Remanufactured Components

Hitachi offers different lines of parts and components to suit your specific needs. In addition to our range of genuine parts, there are other options available:

- If your machines have been working for several years, Hitachi can offer a second line of genuine parts as an attractively priced solution.
- For that highly demanding application or climate, Hitachi provides a line of parts with extra performance.
- When you are looking for an economical solution for preventive replacements, remanufactured components are the best option.

Whatever choice you make, you can be assured of the renowned Hitachi quality and warranty to give you added peace of mind.

Your Hitachi dealer can supply you with more details on each of the above parts lines.



* The GPRS communication system is standard equipment for new ZAXIS excavators, however, the availability of the communication system depends on licensing regulations in your country. Please contact your Hitachi dealer for more information or to apply for a Global e-Service account.

Key features

- Check each of your machines from your office – 24/7
- Have a remote insight into fuel consumption
- Check the current and previous locations and movements of your machine(s)

- See maintenance status and items due for renewal on each of your machines
- Receive e-mail notifications for any machine alerts, unexpected movements and so on

WORKING RANGES

High Reach Demolition 25 m

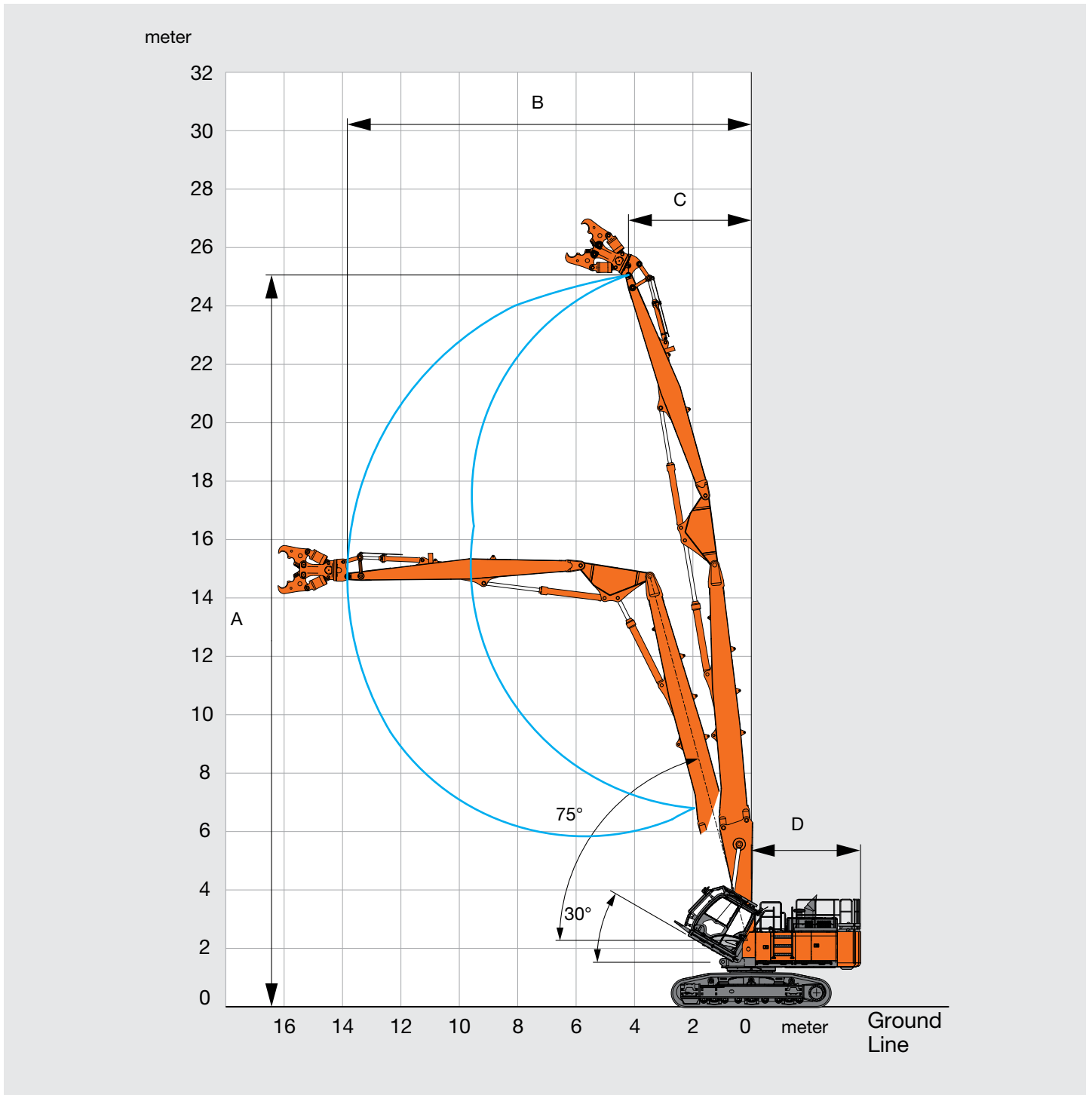

Unit: mm

	High Reach Demolition 25 m
A Max. working height (arm top point)	25 060
B Forward limited working reach (arm top point)	13 840
C Reach at max. height (arm top point)	4 210
D Rear-end swing radius	3 860
*Max. tool weight	3 000 kg

*Including quick hitch

SPECIFICATIONS

WORKING RANGES

High Reach Demolition 27 m

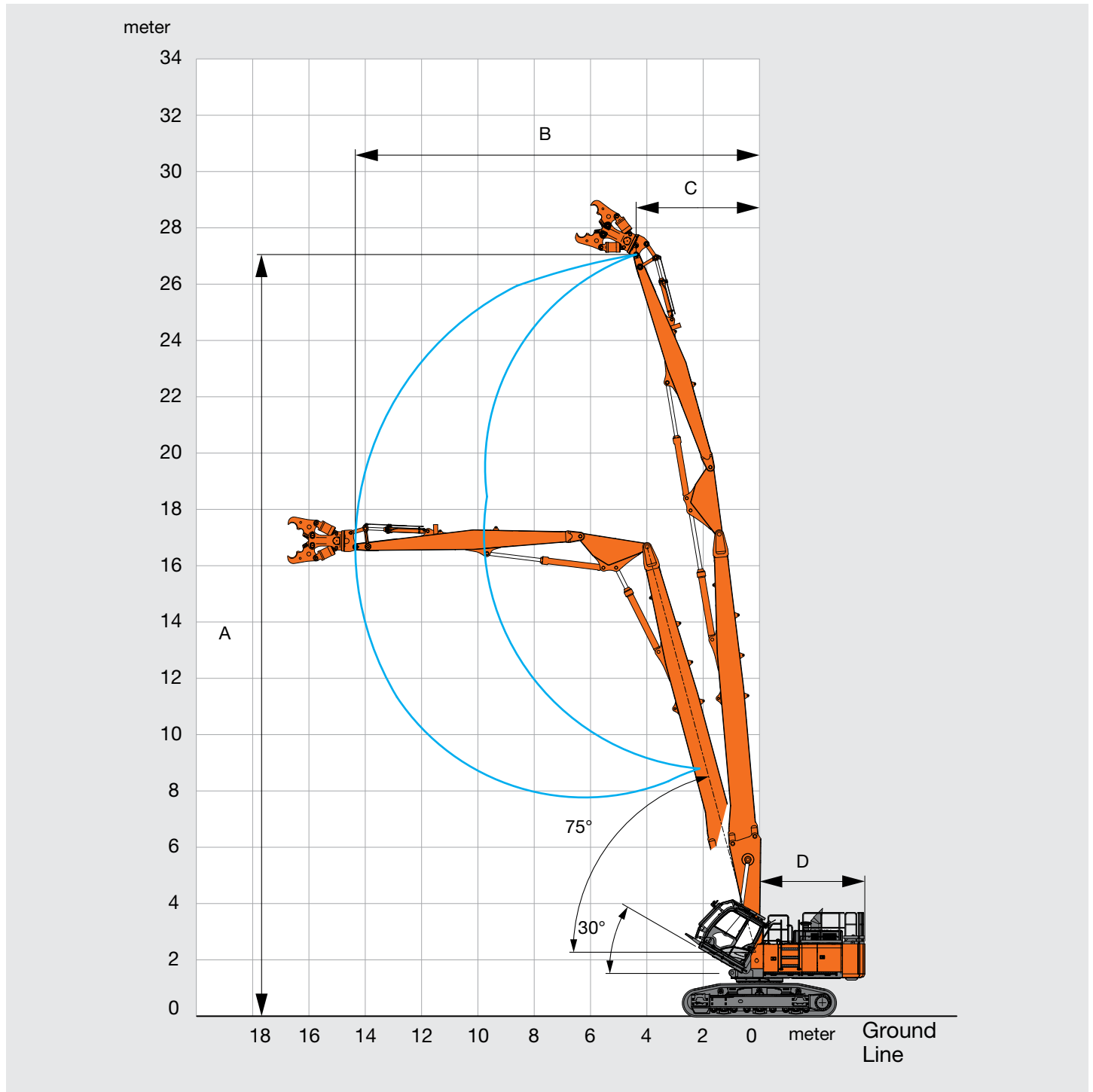

Unit: mm

	High Reach Demolition 27 m
A Max. working height (arm top point)	27 050
B Forward limited working reach (arm top point)	14 350
C Reach at max. height (arm top point)	4 380
D Rear-end swing radius	3 860
*Max. tool weight	2 500 kg

*Including quick hitch

WORKING RANGES

Demolition 2-Piece Boom

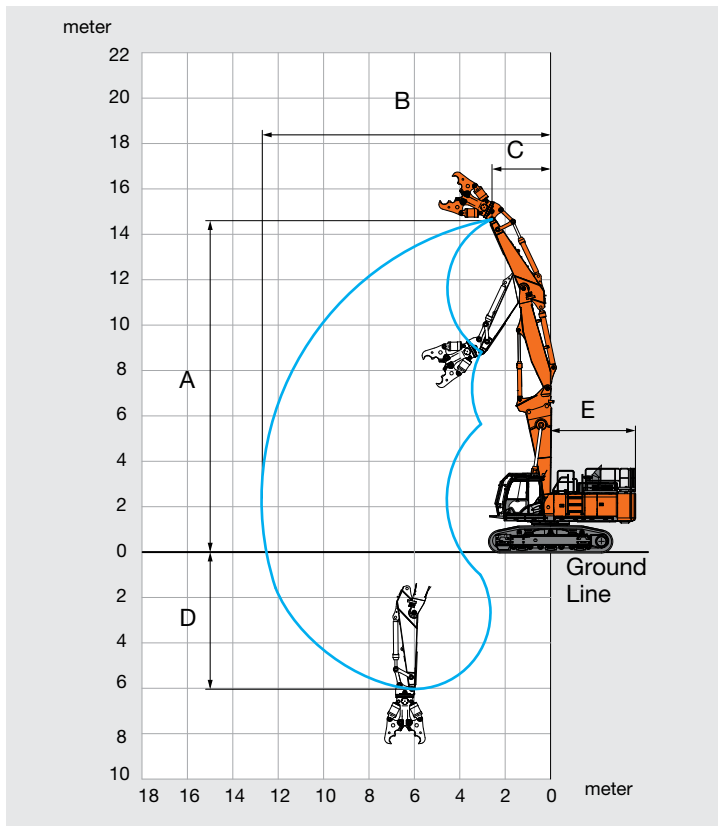

Unit: mm

	Demolition 2-Piece Boom	
A	Max. working height (arm top point)	14 600
B	Max. working reach (arm top point)	12 700
C	Reach at max. height (arm top point)	2 580
D	Max. working depth (arm top point)	6 040
E	Rear-end swing radius	3 860
*Max. tool weight		4 500 kg

*Including quick hitch

WORKING RANGES

Mono Block Boom

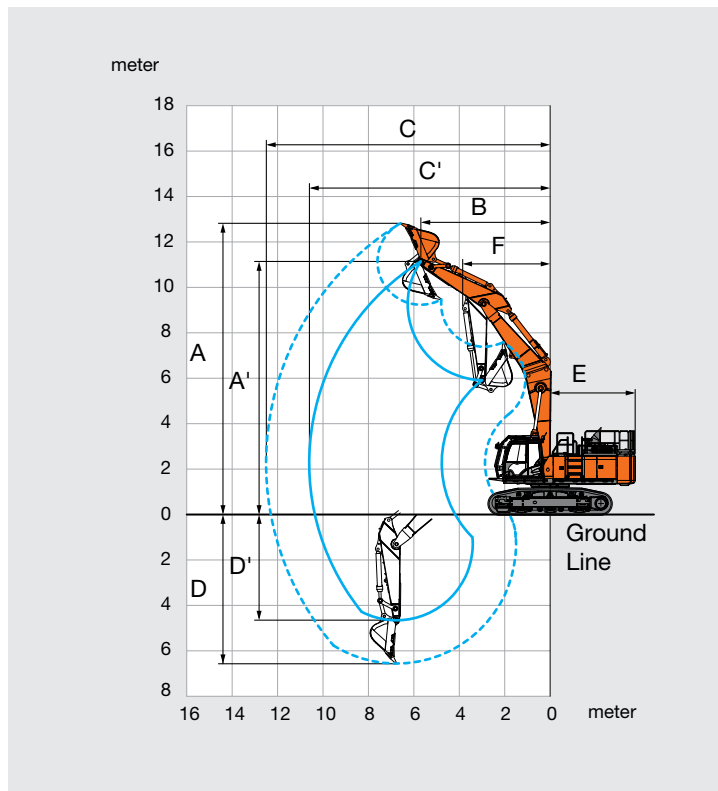

Unit: mm

	Mono Block Boom	
A	Max. digging height (bucket)	12 820
A'	Max. working height (arm top point)	11 140
B	Reach at max. height (arm top point)	5 690
C	Max. digging reach (bucket)	12 500
C'	Max. working reach (arm top point)	10 600
D	Max. digging depth (bucket)	6 550
D'	Max. working depth (arm top point)	4 650
E	Rear-end swing radius	3 860
F	Min. swing radius (bucket)	3 850
Bucket digging force ISO		296 kN (30 200 kgf)
Arm crowd force ISO		224 kN (22 900 kgf)
*Max. tool weight		4 500 kg

*Including quick hitch

LIFTING CAPACITIES

Metric measure

- Notes: 1. Ratings are based on ISO 10567.
 2. Lifting capacity of the ZAXIS Series does not exceed 75% of tipping load with the machine on firm, level ground or 87% of full hydraulic capacity.
 3. The load point is the center line of the bucket pivot mounting pin on the arm.
 4. *Indicates load limited by hydraulic capacity.
 5. 0 m = Ground.

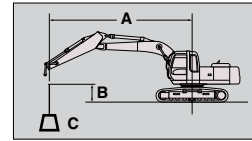

A: Load radius
 B: Load point height
 C: Lifting capacity

For lifting capacities, subtract bucket and quick hitch weight from lifting capacities.

Demolition 2-Piece Boom

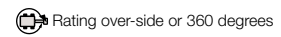
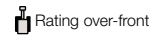

Unit : kg

Conditions	Load point height m	Load radius m														At max.reach					
		3.0		4.5		6.0		7.5		9.0		10.5		12.0		meter					
H-arm: 3.4 m	13.5			*15 200	*15 200													*11 300	*11 300	5.84	
Shoe: 600 mm	12.0			*13 000	*13 000	*13 400	*13 400	*12 500	*12 500										*9 050	*9 050	8.14
Counterweight: 14 400 kg	10.5			*11 600	*11 600	*13 100	*13 100	*13 100	*13 100	*12 000	10 300								*8 020	*8 020	9.67
	9.0			*12 700	*12 700	*14 100	*14 100	*14 000	*14 000	*13 400	10 700	*10 400	7 570						*7 460	*7 080	10.8
	7.5	*35 900	*35 900	*28 000	*28 000	*18 900	*18 900	*16 600	14 400	*14 200	10 800	12 000	7 820						*7 160	6 100	11.6
	6.0	*28 200	*28 200	*26 900	*26 900	*21 900	*18 900	*17 300	14 000	*14 300	10 600	*11 900	7 820	9 260	5 660				*7 020	5 480	12.2
	4.5			*26 300	*26 300	*21 700	18 500	*17 400	13 400	*14 300	10 100	*11 800	7 690	9 260	5 670				*7 010	5 110	12.5
	3.0					*21 800	16 800	*17 200	12 400	*14 100	9 550	11 800	7 450	9 170	5 570				*7 130	4 910	12.7
	1.5					*22 000	15 500	*17 200	11 600	*14 200	9 040	11 500	7 170	9 040	5 440				*7 360	4 860	12.7
	0 (Ground)			*13 500	*13 500	*22 100	14 800	*17 400	11 100	14 200	8 660	11 300	6 880	*8 590	5 330				*6 400	4 970	12.5
	-1.5			*20 400	*20 400	*21 300	14 600	*17 100	10 800	13 900	8 430	11 000	6 650	*5 820	5 330				*5 110	*5 110	12.1
-3.0			*24 200	22 700	*19 800	14 600	*16 000	10 700	*13 000	8 390	*8 650	6 560						*5 730	*5 730	11.2	
-4.5			*20 700	*20 700	*17 200	14 900	*13 900	10 900	*9 520	8 340								*7 050	*7 050	9.69	

Mono Block Boom

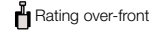

Unit : kg

Conditions	Load point height m	Load radius m												At max.reach							
		3.0		4.5		6.0		7.5		9.0		10.5		meter							
H-arm: 3.4 m	9.0							*11 000	*11 000									*7 660	*7 660	8.15	
Shoe: 600 mm	7.5					*14 600	*14 600	*13 700	*13 700	*8 930	*8 930								*7 340	*7 340	9.20
Counterweight: 11 500 kg	6.0			*24 600	*24 600	*19 500	*19 500	*16 500	14 400	*12 900	10 800								*7 280	*7 280	9.91
	4.5			*29 400	29 200	*21 600	19 100	*17 600	13 800	*15 100	10 500								*7 430	*7 430	10.4
	3.0					*23 500	17 900	*18 600	13 200	*15 600	10 200	*8 690	8 060						*7 760	*7 760	10.6
	1.5					*24 300	17 100	*19 100	12 600	15 300	9 850	*9 340	7 910						*8 330	7 830	10.6
	0 (Ground)			*13 500	*13 500	*23 800	16 600	*19 000	12 300	15 100	9 620								*9 220	7 960	10.3
	-1.5			*20 400	*20 400	*22 200	16 400	*17 900	12 100	*14 500	9 510								*10 600	8 430	9.89
-3.0			*22 800	*22 800	*19 300	16 500	*15 800	12 100	*12 100	9 590								*11 600	9 370	9.17	

OVERALL

High reach demolition 25 m

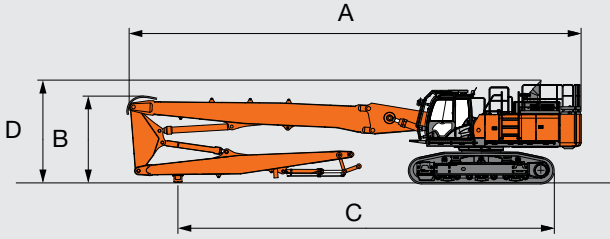

Unit: mm

High reach demolition 25 m

A Transport length	17 000
*B Overall height of front	3 300
C Length on ground	14 100
*D Overall height	3 870

*Including track shoe lug

Demolition 2-piece boom

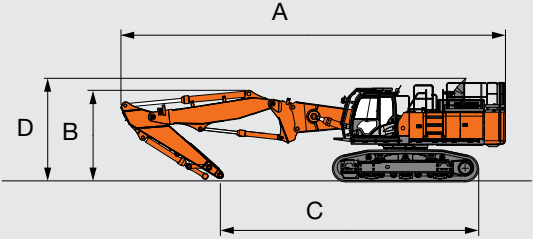

Unit: mm

Demolition 2-piece boom

A Transport length	14 400
*B Overall height of front	3 430
C Length on ground	9 680
*D Overall height	3 870

*Including track shoe lug

High reach demolition 27 m

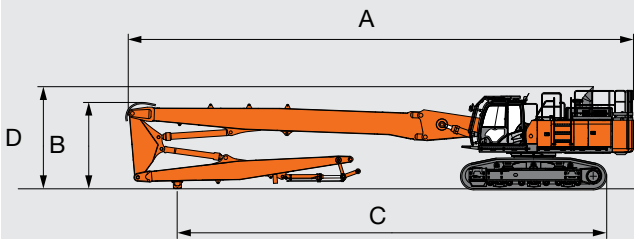

Unit: mm

High reach demolition 27 m

A Transport length	19 000
*B Overall height of front	3 300
C Length on ground	16 100
*D Overall height	3 870

*Including track shoe lug

Mono block boom

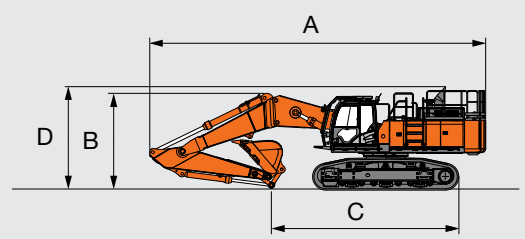

Unit: mm

Mono block boom

A Transport length	12 580
*B Overall height of front	3 620
C Length on ground	7 020
*D Overall height	3 870

*Including track shoe lug

EQUIPMENT

●Standard equipment ○Optional equipment

ENGINE

Auto idle system	●
Cartridge-type engine oil filter	●
Cartridge-type fuel filter	●
Dry-type air double filter with evacuator valve (with air filter restriction switch for monitor)	●
Fan guard	●
Fuel pre-filter	●
Isolation-mounted engine	●
Muffler filter	●
Power mode control [H/P (High Power) PWR (Power) ECO (Economy)]	●
Pre-cleaner	○
Radiator, oil cooler and intercooler with dust protective net	●
Radiator reserve tank	●
50 A alternator	●

HYDRAULIC SYSTEM

Accessories for breaker	●
Accessories for breaker & crusher	●
Accessories for 2 speed selector	●
Additional pump (30 L/min)	●
Auto power lift	●
Boom mode selector system	●
Control valve with main relief valve	●
Drain filter	●
Engine speed sensing system	●
E-P control system	●
Extra port for control valve	●
Full-flow filter	●
Pilot filter	●
Power boost	●
Quick warm-up system for pilot circuit	●
Shockless valve in pilot circuit	●
Suction filter	●
Work mode selector	●

CAB

Additional fuse box	●
Adjustable armrests	●
All-weather sound suppressed steel cab	●
AM-FM radio	●
Ashtray	●
Auto control air conditioner	●
Auto-idle selector	●
AUX. terminal and storage	●
Demolition cab :	
FOPS for excavators compliant cab	●
Intermittent windshield wiper (Parallel type)	●
Laminated round glass (green color) front window	●
Left side windows can be opened	●
OPG top guard fitted Level II (ISO10262)	●
OPG front guard fitted Level II (ISO10262)	●
Pillar-less front window	●
Roof window with wiper and washer	●
Cigarette lighter	●
Drink holder	●
Engine shut-off switch	●
Electric double horn	●
Evacuation hammer	●
Floor mat	●
Footrest	●
Front window washer	●
Glove compartment	●
Hot & cool box	●
LED room light with door courtesy	●
Pilot control shut-off lever	●
Retractable seat belt	●
Rubber radio antenna	●
Seat : Adjustable reclining air suspension with heater	●
Short wrist control levers	●
Storage box	●
Sun visor (front)	○
Sun visor (side)	○
Tilting cab	●
Transparent roof with slide curtain	●
6 fluid-filled elastic mounts	●
12 V power outlet	○

MONITOR SYSTEM

Alarm buzzers: overheat, engine oil pressure, overload, boom angle, swing angle, tilting cab	●
Alarms: overheat, engine warning, engine oil pressure, alternator, minimum fuel level, air filter restriction, work mode, overload, etc	●
Display of meters: water temperature, hour, fuel rate, clock	●
Other displays: work mode, auto-idle, glow, rearview monitor, operating conditions, etc	●

LIGHTS

2 cab lights	●
2 working lights	●
Additional working light (Boom right side)	●
Additional cab roof rear light	●
Rotating lamp	●

UPPER STRUCTURE

Electric fuel refilling pump with auto stop	●
Electrical grease pump with hose-reel	●
Fuel level float	●
Hydraulic oil level gauge	●
Ladder	●
Rear view camera	●
Rear view mirrors (right & left side)	●
Sidewalk (cab side)	●
Swing parking brake	●
Tool box	●
170 Ah batteries	●
6.0 mm thickness undercover	●
Counterweight	●

UNDERCARRIAGE

Bolt-on sprocket	●
Hydraulic track adjuster	●
Idler track adjuster	●
Reinforced track links with pin seals	●
Travel motor covers	●
Travel parking brake	●
Track undercover	●
Upper and lower rollers	●
3 track guards (each side)	●
600 mm triple grouser shoes	●

FRONT ATTACHMENTS

Centralized lubrication system	●
Damage prevention plate and square bars (Backhoe arm)	●
Dirt seal on all bucket pins	●
Hose rupture valves	○
Storage stand : High reach demolition	●
Mono block boom	●
2-Piece boom	●
Tilt cylinder guard (High reach demolition)	●
Welded bucket link A (2-Piece boom / mono block boom)	●
Welded bucket link A (High reach demolition)	●
1.9 m ³ (ISO heaped) rock bucket (with dual type side shrouds)	○

MISCELLANEOUS

Anti-slip steps and handrails	●
Extinguisher	○
Lockable fuel refilling cap	●
Lockable machine covers	●
Onboard information controller	●
Standard tool kit	●
Swing motion alarm device with lamps	○
Theft prevention system*	○
Travel direction mark on track frame	●
Travel motion alarm device	○
Global e-service	●

Standard and optional equipment may vary by country, so please consult your Hitachi dealer for details.
* Hitachi Construction Machinery cannot be held liable for theft, any system will just minimize the risk of theft.



Built on the foundation of superb technological capabilities, Hitachi Construction Machinery is committed to providing leading-edge solutions and services to contribute as a reliable partner to the business of customers worldwide.



Hitachi Environmental Vision 2025

The Hitachi Group released the Environmental Vision 2025 to curb annual carbon dioxide emissions. The Group is committed to global production while reducing environmental impact in life cycles of all products, and realizing a sustainable society by tackling three goals — prevention of global warming, recycling of resources, and enhancement of ecosystem.

Reducing Environmental Impact by New ZAXIS

Hitachi makes a green way to cut carbon emissions for global warming prevention according to LCA*. New ZAXIS utilizes lots of technological advances, including the new ECO mode, and Isochronous Control. Hitachi has long been committed to recycling of components, such as aluminum parts in radiators and oil cooler. Resin parts are marked for recycling.

*Life Cycle Assessment – ISO 14040

Prior to operating this machine, including satellite communication system, in a country other than a country of its intended use, it may be necessary to make modifications to it so that it complies with the local regulatory standards (including safety standards) and legal requirements of that particular country. Please do not export or operate this machine outside the country of its intended use until such compliance has been confirmed. Please contact your Hitachi dealer in case of questions about compliance. These specifications are subject to change without notice.

Illustrations and photos show the standard models, and may or may not include optional equipment, accessories, customer installed and modified parts, optional parts and all standard equipment with some differences in color and features. Before use, read and understand the Operator's Manual for